

# MIGHTY 600



**Item# F-MTY600**  
600 lb weight capacity  
Up to 14" deck to water

The new Mighty Lifts are UL Certified, ADA compliant lifts designed to provide versatility and accessibility solutions with greater water drafts and setbacks up to 44 inches.

The Mighty series features an adjustable height seat pole allowing 4" of additional adjustment in 2" increments.

In addition the Mighty's can rotate 360 degrees in either direction. Designed for in ground anchoring, the Mighty series will accommodate existing "standard" Scout 2 and Revolution concrete anchors. Created for its adaptability, the Mighty's can be purchased with a pedestal for additional wall clearance or unusual gutter profiles. Pedestals come in 1', 2', 3', and 4' options.

The Mighty series is ideal for easy and affordable ADA compliance. US Patent Pending.

All lifts come standard in white with blue seat and footrest. Additional color options are available for both plastics and powder coat.

## FEATURES:

- UL certified
- 600 LB weight capacity
- Up to 14" deck to water
- 360 degree rotation
- Setback up to 44"
- Adjustable seat height
- Direct drive rotation
- Flip-up armrests
- Stainless steel construction
- Durable powder coat finish
- Five year pro-rated electronics warranty
- Five year structural warranty

pedestal accessory



U.S. Patent No.  
D507,769S

## ACCENT COLORS

Available in a variety of accent and powder coat colors



\*Blue seat standard (not a powder coat option)

## OPTIONS/ACCESSORIES:

F-808SA	Anchor kit, standard 1.9" ID x 6" deep
F-808SA-10	Anchor, 10" for pavers
F-77SSA	Anchor, Semi-Recessed, Shallow Concrete
F-MTLC	Cover, standard, blue
F-MTLC-T	Cover, standard, tan
F-MTLC-G	Cover, standard, gray
F-422PLH-2	Headrest
F-LRB	Pull-out leg rest assembly (blue, tan, gray, or white)
F-048SCH	Solar charging station
F-MTTC	Mighty series transport cart
F-MTY1PD	Pedestal, 1 foot tall
F-MTY2PD	Pedestal, 2 foot tall
F-MTY3PD	Pedestal, 3 foot tall
F-MTY4PD	Pedestal, 4 foot tall

## PROUDLY SOLD BY:

**strack** Liftsysteme

Strack AG  
Ebnatstrasse 125  
8200 Schaffhausen

Tel. 0800 600 500  
Fax 0800 600 900

www.strack.ch  
info@strack.ch

ZSR-Nr. K 7514.14  
NIF-Nr. 366 824  
MWST-Nr. 567 970

# THE MIGHTY 600 POOL LIFT

## PRODUCT SPECIFICATIONS

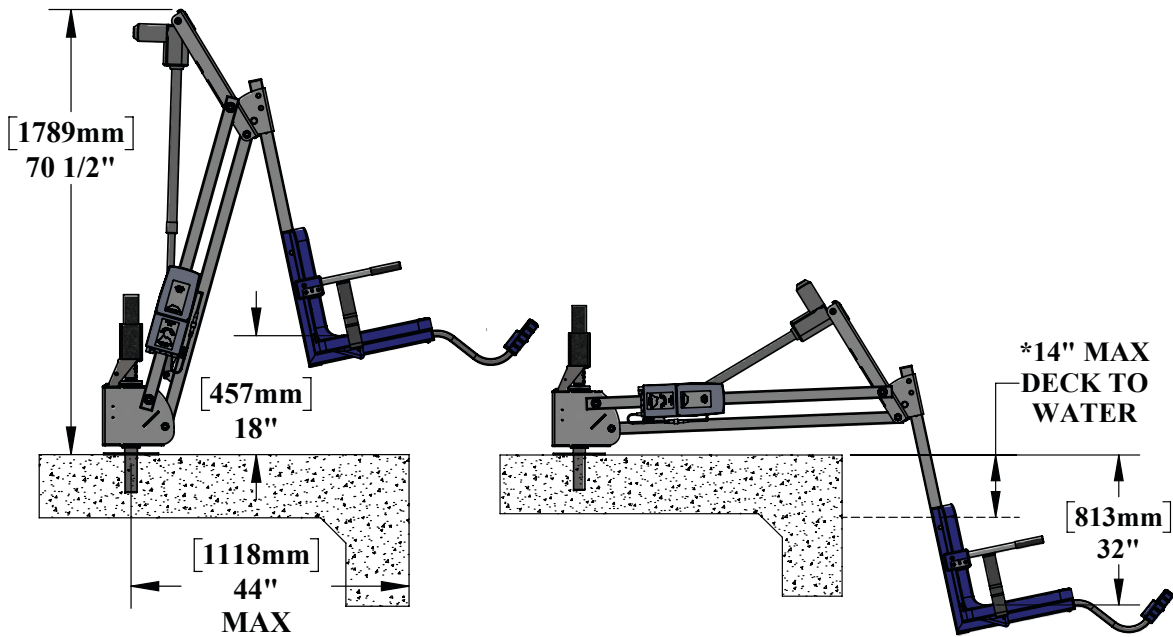

## APPLICABLE POOL PROFILES

### WITHOUT PEDESTAL

ROLL OUT

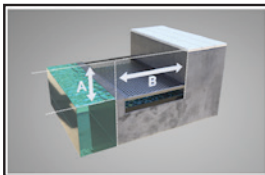

PARTIALLY RECESSED

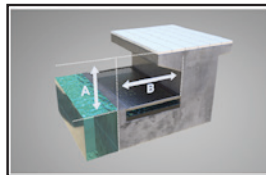

FULLY RECESSED

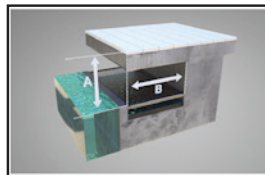

BULL NOSE

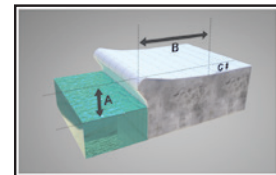

### WITH PEDESTAL

RAISED POOL / SPA

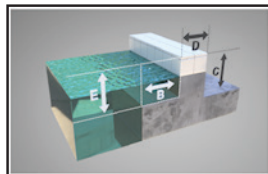

FLORIDA ROLL OUT

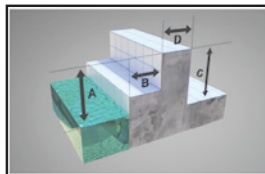

PARTIALLY RECESSED  
W/ CURB

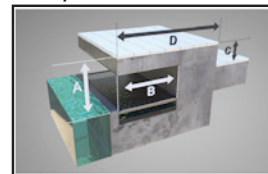

To confirm specific application go to [www.aquacreek.com](http://www.aquacreek.com) for our Pool Lift Selector  
Become a member of our new Dealer and Architect page. Access to CAD blocks,  
CSI specs and sales materials.